

Acme[®]

ENERGY HYBRID

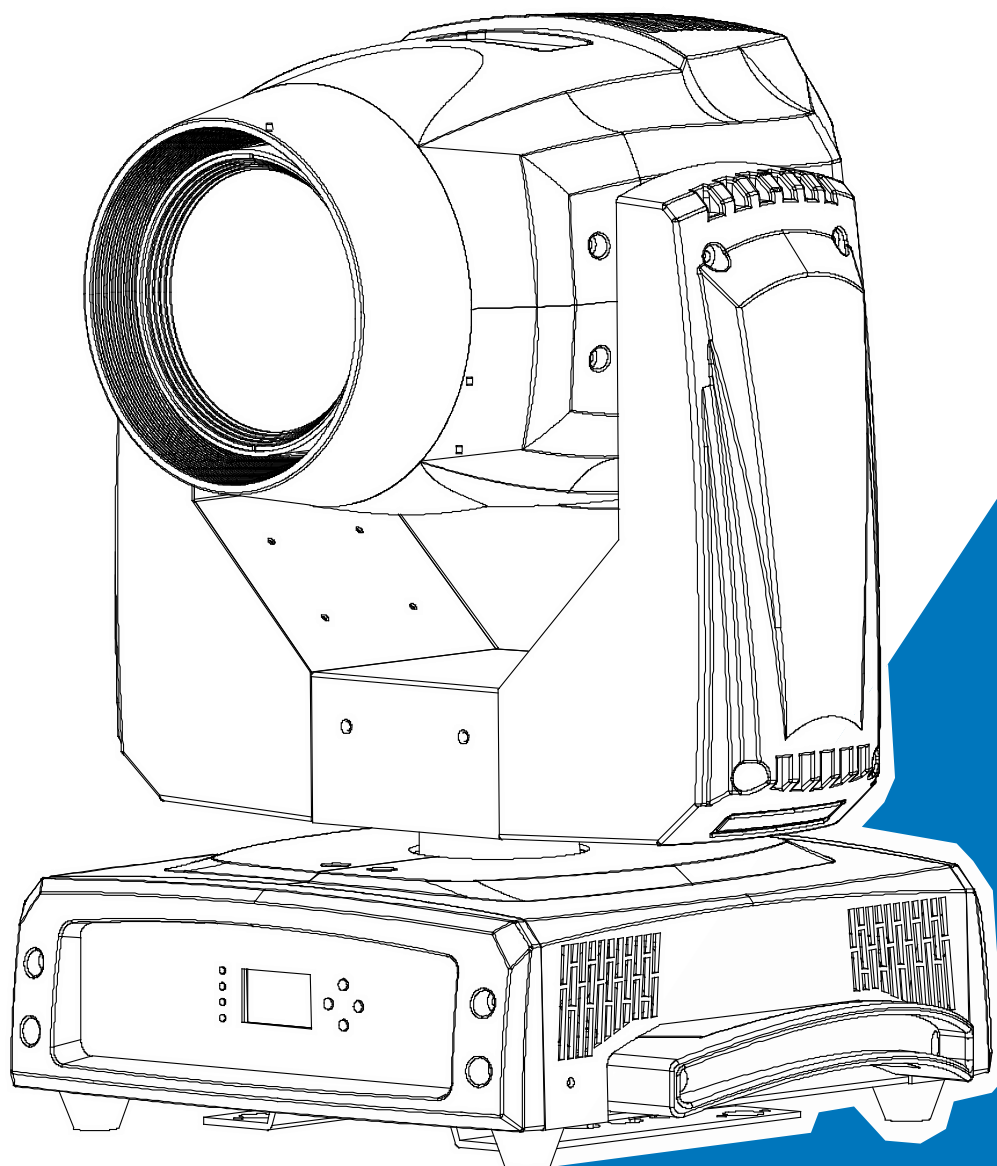

User Manual

Please read the instruction carefully before use

CONTENTS

1. Safety Instructions	2
2. Technical Specifications	4
3. Control Panel	6
4. Effect Wheels	7
5. How To Set The Unit.....	7
5.1 Main Function.....	7
5.2 Home Position Adjustment	15
6. Control By Universal DMX Controller	17
6.1 DMX512 Connection	17
6.2 Address Setting	18
6.3 DMX512 Configuration.....	18
7. Troubleshooting	24
8. Fixture Cleaning	25

1. Safety Instructions



Please read the instruction carefully which includes important information about the installation, usage and maintenance.

WARNING

Please keep this User Guide for future consultation. If you sell the unit to another user, be sure that they also receive this instruction manual.

Important:

Damages caused by the disregard of this user manual are not subject to warranty. The dealer will not accept liability for any resulting defects or problems.

- Unpack and check carefully to ensure that there is no transportation damage before using the unit.
- This product is for indoor use only. Use only in a dry location.
- DO install and operate by qualified operator.
- DO NOT allow children to operate the fixture.
- Use safety chain when fixing the unit. Handle the unit by carrying its base instead of head only.
- The unit must be installed in a location with adequate ventilation, at least 50cm from adjacent surfaces.
- Be sure that no ventilation slots is blocked, otherwise the unit will be overheated.
- Before operation, ensure that you are connecting this product to the proper voltage in accordance with the specifications in this manual or on the product's specification label.
- It's important to ground the yellow/green conductor to earth in order to avoid electric shock.
- Minimum ambient temperature TA: 0°C. Maximum ambient temperature TA: 40°C. Do not operate this product at a lower or higher temperature.
- DO NOT connect the device to any dimmer pack.
- Keep flammable materials away from the fixture while operating to avoid fire hazard.
- Make sure the power cord is not crimped or damaged; replace it immediately if damaged.
- Avoid any flammable liquids, water or metal from entering the unit. Once it happens, cut off the mains power immediately.
- DO NOT operate in a dirty or dusty environment. DO clean the fixture regularly.
- DO NOT touch any wire during operation as there might be a hazard of electric shock.

- Avoid entanglement of the power cord with other wires.
- The minimum distance to objects/surface must be more than 2 meters.
- Disconnect mains power before fuse replacement or servicing.
- Replace fuse only with the same type.
- In the event of serious operating problem, stop using the unit immediately.
- Never turn on and off the unit time after time.
- The housing, the lenses, or the ultraviolet filter must be replaced if they are visibly damaged.
- DO NOT open the housing as there are no user serviceable parts inside.
- DO NOT attempt to operate this unit if it becomes damaged. DO NOT attempt any repairs yourself. Repairs carried out by unskilled people can lead to damage or malfunction. Please contact the nearest authorized technical assistance center if needed.
- Disconnect this product from its power source before servicing.
- DO use the original packaging if the device is to be transported.
- Avoid direct eye exposure to the light source while the product is on.
- DO NOT operate this product if you see damage on the housing, shields, or cables. Have the damaged parts replaced by an authorized technician at once.

Installation:

The fixture should be fixed on the clamp. Always ensure that the unit is firmly fixed to avoid vibration and slipping off during operation. Ensure that the trussing or area of installation must be able to hold 10 times the weight without any deformation. Always install a safety cable that can hold at least 12 times the weight of the fixture when installing.

DO install and operate by qualified operator. It must be installed in a place where there is out of the reach of people.

2. Technical Specifications

Power Voltage:

AC 100~240V, 50/60Hz

Power Consumption:

305W

Light Source:

TX-5266W300FC120

Beam Angle:

1°/3°/6.5°/10°

2°/6°/13°/20° (with zoom lens)

Spot Angle:

Static Gobo: 9°→18° (with zoom lens)

Rotating Gobo: 7.5°→13° (with zoom lens)

Wash Angle:

12°~23°

Movement:

Pan: 540°

Tilt: 240°

Pan/Tilt Resolution: 16 bit

Dimmer/Shutter:

0~100% smooth dimming, various strobe speeds

Color Wheel:

1 x color wheel with 7 fixed colors plus open and rainbow effect

Gobo Wheel:

1 x static gobo wheel with 9 fixed gobos plus open

1 x rotating gobo wheel with 7 gobos plus open

Control:

DMX Channel: 16/19 channels

Control Mode: DMX512, RDM, Primary/Secondary, Sound Active

Firmware Upgrade: Update via DMX link

Construction:

Display: LCD display

Data In/Out: 3-pin & 5-pin XLR

Power In/Out: Power Connector in/out

Protection Rating: IP20

Features:

Motorized focus

6-facet prism rotating in both directions

Outstanding color macro effect

Independent frost effect

Integrated three features: beam, spot, and wash

Dimension/Weight:

435x344x560mm, 21kgs

17.1"x13.5"x22" in, 46.3lbs

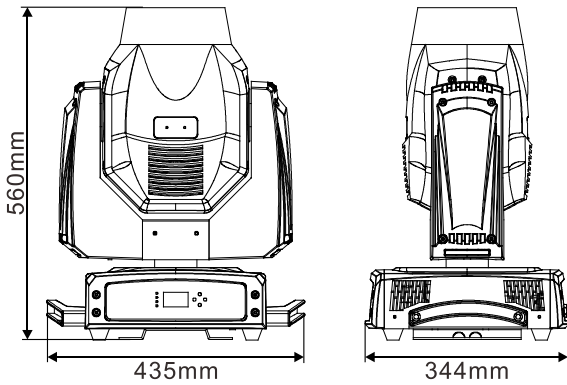

Photometric Diagram:

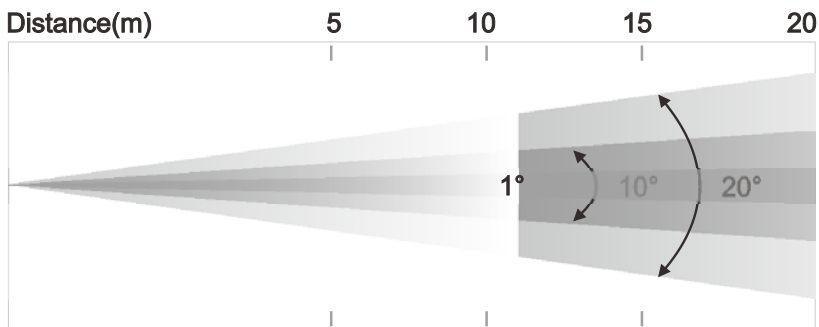

Distance(m)	5	10	15	20
1°Lux	23800	5780	2590	1444
Diameter(m)	0.09	0.18	0.26	0.35
10°Lux	20700	5100	2253	1248
Diameter(m)	0.84	1.76	2.63	3.44
20°Lux	6100	1470	670	423
Diameter(m)	1.76	3.52	5.3	7.05

3. Control Panel

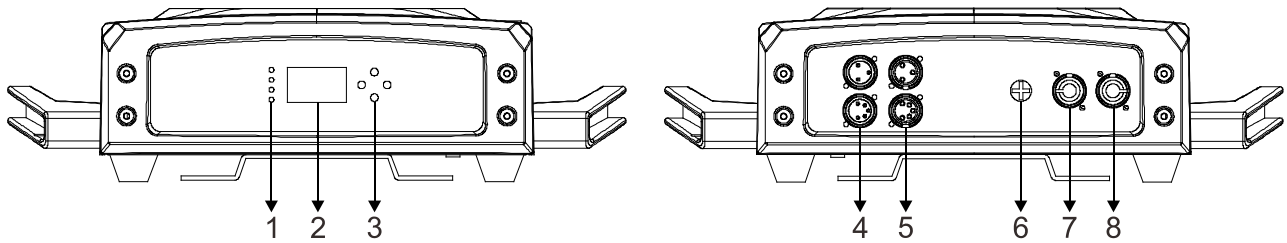

1. LED:

PRIMARY	On	Primary mode
SECONDARY	On	Secondary mode
SOUND	On	Sound activation
DMX	On	DMX input present

2. Display: To show the various menus and the selected function

3. Button:

MENU	To enter into move backward or leave the menu
UP	To go backward to move up in the menu
DOWN	To go forward to move down in the menu
ENTER	To perform the desired functions

4. DMX IN:

For DMX512 link, use 3/5-pin XLR cable to link the unit and DMX controller

5. DMX OUT:

For DMX512 link, use 3/5-pin XLR cable to link the next units

6. FUSE(T 10A): Protect the unit from damage of over current or short-circuit

7. POWER IN: To connect to supply power

8. POWER OUT: To connect to the next fixture

4. Effect Wheels

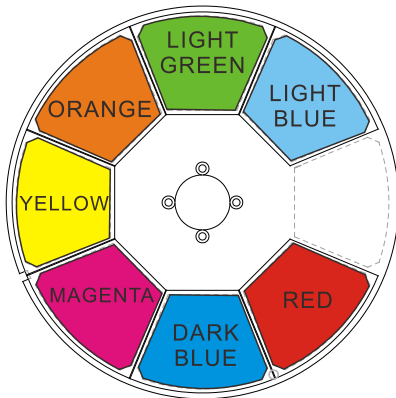

Color Wheel

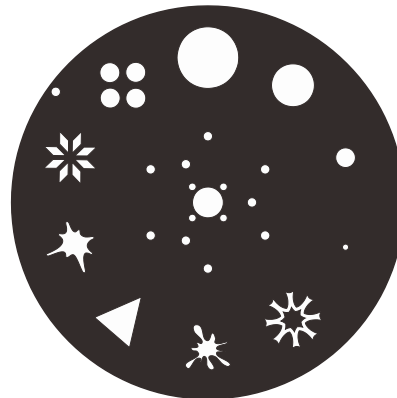

Static Gobo Wheel

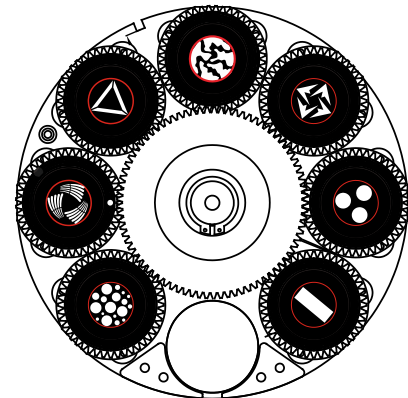

Rotating Gobo Wheel

DANGER!

***Install the gobos with the device switched off only.
Unplug from mains before changing gobos!***

CAUTION: Never unscrew the screws of the rotating gobo as the ball bearing will otherwise be opened!

5. How To Set The Unit

5.1 Main Function

Turn on the unit, press the MENU button into menu mode, and press the UP/DOWN button until the required function is shown on the monitor. Select the function by pressing the ENTER button. Use the UP/DOWN button to choose the submenu, press the ENTER button to store and automatically return to the last menu. Press the MENU button or let the unit idle 30 seconds to exit menu mode.

The main functions are shown below:

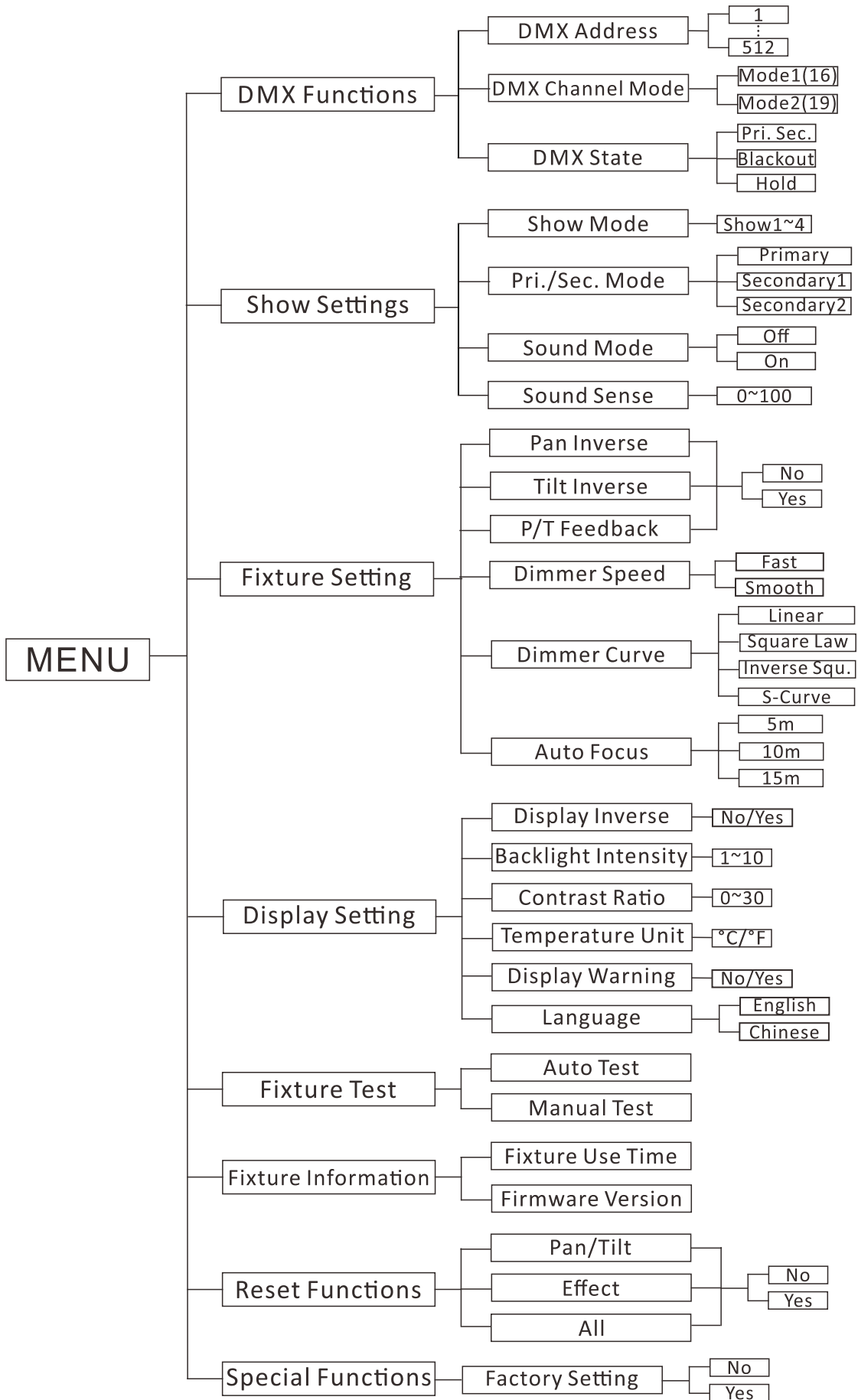

DMX Functions

To select **DMX Functions**, press the **ENTER** button to confirm, use the **UP/DOWN** button to select **DMX Address**, **DMX Channel Mode** or **DMX State**.

DMX Address

To select **DMX Address**, press the **ENTER** button to confirm. Use the **UP/DOWN** button to adjust the address from **001** to **512**, press the **ENTER** button to store. Press the **MENU** button back to the last menu or let the unit idle 30 seconds to exit menu mode.

DMX Channel Mode

To select **DMX Channel Mode**, press the **ENTER** button to confirm. Use the **UP/DOWN** button to select **Mode1(16)** or **Mode2(19)**, press the **ENTER** button to store. Press the **MENU** button back to the last menu or let the unit idle 30 seconds to exit menu mode.

DMX State

To select **DMX State**, press the **ENTER** button to confirm. Use the **UP/DOWN** button to select **Pri. Sec.**(fixture enters to primary secondary mode), **Blackout**(fixture blacks out if DMX signal stops) or **Hold**(fixture continues to obey the last command it received Via DMX if DMX signal stops), press the **ENTER** button to store. Press the **MENU** button back to the last menu or let the unit idle 30 seconds to exit menu mode.

Show Settings

To select **Show Settings**, press the **ENTER** button to confirm, use the **UP/DOWN** button to select **Show Mode**, **Pri./Sec. Mode**, **Sound Mode** or **Sound Sense**.

Show Mode

To select **Show Mode**, press the **ENTER** button to confirm. Use the **UP/DOWN** button to select **Show1**, **Show2**, **Show3** or **Show4**, press the **ENTER** button to store. Press the **MENU** button back to the last menu or let the unit idle 30 seconds to exit menu mode.

Pri./Sec. Mode

To select **Pri./Sec. Mode**, press the **ENTER** button to confirm. Use the **UP/DOWN** button to select **Primary**, **Secondary1** or **Secondary2**, press the **ENTER** button to store. Press the **MENU** button back to the last menu or let the unit idle 30 seconds to exit menu mode.

Sound Mode

To select **Sound Mode**, press the **ENTER** button to confirm. Use the **UP/DOWN** button to select **Off** or **On**, press the **ENTER** button to store. Press the **MENU** button back to the last menu or let the unit idle 30 seconds to exit menu mode.

Sound Sense

To select **Sound Sense**, press the **ENTER** button to confirm. Use the **UP/DOWN** button to adjust the sound sense from **0** to **100**, press the **ENTER** button to store. Press the **MENU** button back to the last menu or let the unit idle 30 seconds to exit menu mode.

Fixture Setting

To select **Fixture Setting**, press the **ENTER** button to confirm, use the **UP/DOWN** button to select **Pan Inverse**, **Tile Inverse**, **P/T Feedback**, **Dimmer Speed**, **Dimmer Curve** or **Auto Focus**.

Pan Inverse

To select **Pan Inverse**, press the **ENTER** button to confirm. Use the **UP/DOWN** button to select **No** (normal) or **Yes** (pan inverse), press the **ENTER** button to store. Press the **MENU** button back to the last menu or let the unit idle 30 seconds to exit menu mode.

Tilt Inverse

To select **Tilt Inverse**, press the **ENTER** button to confirm. Use the **UP/DOWN** button to select **No** (normal) or **Yes** (tilt inverse), press the **ENTER** button to store. Press the **MENU** button back to the last menu or let the unit idle 30 seconds to exit menu mode.

P/T Feedback

To select **P/T Feedback**, press the **ENTER** button to confirm. Use the **UP/DOWN** button to select **No** (Pan or tilt's position will not feedback while out of step) or **Yes** (Feedback while pan/tilt out of step), press the **ENTER** button to store. Press the **MENU** button back to the last menu or let the unit idle 30 seconds to exit menu mode.

Dimmer Speed

To select **Dimmer Speed**, press the **ENTER** button to confirm. Use the **UP/DOWN** button to select **Fast** or **Smooth**, press the **ENTER** button to store. Press the **MENU** button back to the last menu or let the unit idle 30 seconds to exit menu mode.

Dimmer Curve

To select **Dimmer Curve**, press the **ENTER** button to confirm. Use the **UP/DOWN** button to select **Linear**, **Square Law**, **Inverse Squ.** or **S-Curve**, press the **ENTER** button to store. Press the **MENU** button back to the last menu or let the unit idle 30 seconds to exit menu mode.

Dimmer Modes

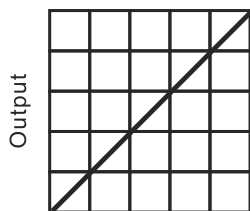

DMX %

Optically Linear

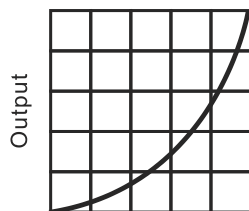

DMX %

Square Law

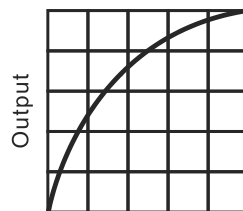

DMX %

Inverse Square Law

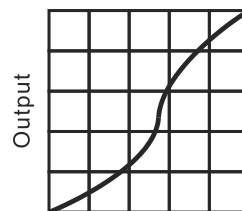

DMX %

S-curve

Optically Linear: The increase in light intensity appears to be linear as DMX value is increased.

Square Law: Light intensity control is finer at low levels and coarser at high levels.

Inverse Square Law: Light intensity control is coarser at low levels and finer at high levels.

S-Curve: Light intensity control is finer at low levels and high levels and coarser at medium levels.

Auto Focus

To select **Auto Focus**, press the **ENTER** button to confirm. Use the **UP/DOWN** button to select **5m**, **10m** or **15m**, press the **ENTER** button to store. Press the **MENU** button back to the last menu or let the unit idle 30 seconds to exit menu mode.

Display Setting

To select **Display Setting**, press the **ENTER** button to confirm, use the **UP/DOWN** button to select **Display Inverse**, **Backlight Intensity**, **Contrast Ratio**, **Temperature Unit**, **Display Warning** or **Language**.

Display Inverse

Select **Display Inverse**, press the **ENTER** button to confirm, present mode will blink on the display, use the **UP/DOWN** button to select **No** (normal display) or **Yes** (inverse display), press the **ENTER** button to store. Press the **MENU** button back to the last menu or let the unit idle 30 seconds to exit menu mode.

Backlight Intensity

Select **Backlight Intensity**, press the **ENTER** button to confirm, present mode will blink on the display, use the **UP/DOWN** button to adjust backlight intensity from **1** (dark) to **10** (bright), press the **ENTER** button to store. Press the **MENU** button back to the last menu or let the unit idle 30 seconds to exit menu mode.

Contrast Ratio

Select **Contrast Ratio**, press the **ENTER** button to confirm, present mode will blink on the display, use the **UP/DOWN** button to adjust value from **0** to **30**, press the **ENTER** button to store. Press the **MENU** button back to the last menu or let the unit idle 30 seconds to exit menu mode.

Temperature Unit

Select **Temperature Unit**, press the **ENTER** button to confirm, present mode will blink on the display, use the **UP/DOWN** button to select °C or °F, press the **ENTER** button to store. Press the **MENU** button back to the last menu or let the unit idle 30 seconds to exit menu mode.

Display Warning

Select **Display Warning**, press the **ENTER** button to confirm, present mode will blink on the display, use the **UP/DOWN** button to select **No** (normal display) or **Yes** (Show service warnings in display panel), press the **ENTER** button to store. Press the **MENU** button back to the last menu or let the unit idle 30 seconds to exit menu mode.

Language

Select **Language**, press the **ENTER** button to confirm, present mode will blink on the display, use the **UP/DOWN** button to select **English** or **Chinese**. Press the **MENU** button back to the last menu or let the unit idle 30 seconds to exit menu mode.

Fixture Test

To select **Fixture Test**, press the **ENTER** button to confirm, use the **UP/DOWN** button to select **Auto Test** or **Manual Test**.

Auto Test

Select **Auto Test**, press the **ENTER** button to confirm, the unit will run built-in programs to automatically test the functions. Press the **MENU** button back to the last menu or exit menu mode after auto test.

Manual Test

Select **Manual Test**, press the **ENTER** button to confirm, the present channel will show on the display, use the **UP/DOWN** button to select channel, press the **ENTER** button to confirm, then use the **UP/DOWN** button to adjust the value, press the **ENTER** button to store, the fixture will run as the channel value indicates. Press the **MENU** button back to the last menu or exit menu mode idling 30 seconds.

(All channels value will become 0 after exiting Manual Test menu)

Fixture Information

To select **Fixture Information**, press the **ENTER** button to confirm, use the **UP/DOWN** button to select **Fixture Use Time** or **Firmware Version**.

Fixture Use Time

Select **Fixture Use Time**, press the **ENTER** button to confirm, fixture use time will show on the display, press the **MENU** button to exit.

Firmware Version

Select **Firmware Version**, press the **ENTER** button to confirm, firmware version will show on the display, press the **MENU** button back to exit.

Reset Functions

To select **Reset Functions**, press the **ENTER** button to confirm, use the **UP/DOWN** button to select **Pan/Tilt**, **Effect** or **All**.

Pan/Tilt

Select **Pan/Tilt**, press the **ENTER** button to confirm, use the **UP/DOWN** button to select **No**(normal) or **Yes**(the unit will run built-in program to reset pan and tilt to their home positions), press the **ENTER** button to store. Press the **MENU** button to exit.

Effect

Select **Effect**, press the **ENTER** button to confirm, use the **UP/DOWN** button to select **No**(normal) or **Yes**(the unit will run built-in program to reset effect to their home positions), press the **ENTER** button to store. Press the **MENU** button to exit.

All

Select **All**, press the **ENTER** button to confirm, use the **UP/DOWN** button to select **No**(normal) or **Yes**(the unit will run built-in program to reset all motors to their home positions), press **ENTER** button to store. Press the **MENU** button to exit.

Special Functions

Factory Settings

Select **Factory Settings**, press the **ENTER** button to confirm, use the **UP/DOWN** button to select **No**(normal) or **Yes**(the fixture will reset to factory settings), press **ENTER** button to store. Press the **MENU** button to exit.

RDM FUNCTIONS

Select the MANUFACTURER menu to display the manufacturer of the fixture.

Select the SOFTWARE VERSION menu and the program version number of the fixture will be displayed.

Select the DMX START ADDRESS menu to change the DMX 512 address (001-512).

Select the DEVICE MODEL DESCRIPTION menu to display the model of the fixture.

Select the DEVICE LABEL menu to change the model of the fixture.

Select the DMX PERSONALITY menu to set the channel mode of the fixture (16/19 channel).

Select the DMX PERSONALITY DESCRIPTION menu to display the current channel mode of the fixture.

Select the DEVICE HOURS menu to display the running time of the fixture.

Select the PAN INVERT menu and the fixture will run the pan invert mode.

Select the TILT INVERT menu and the fixture will run the tilt invert mode.

Select the RESET DEVICE menu, the WARM RESET/COLD RESET option will be displayed. When WARM RESET is selected, the fixture will start a warm reset, and exit when COLD RESET is selected.

5.2 Home Position Adjustment

Press the MENU button into menu mode, then press the ENTER button for about 3 seconds into offset mode to adjust the home position. Select the function by pressing the ENTER button. Use the UP/DOWN button to choose the submenu, press the ENTER button to store and automatically return to the last menu. Press MENU button to exit.

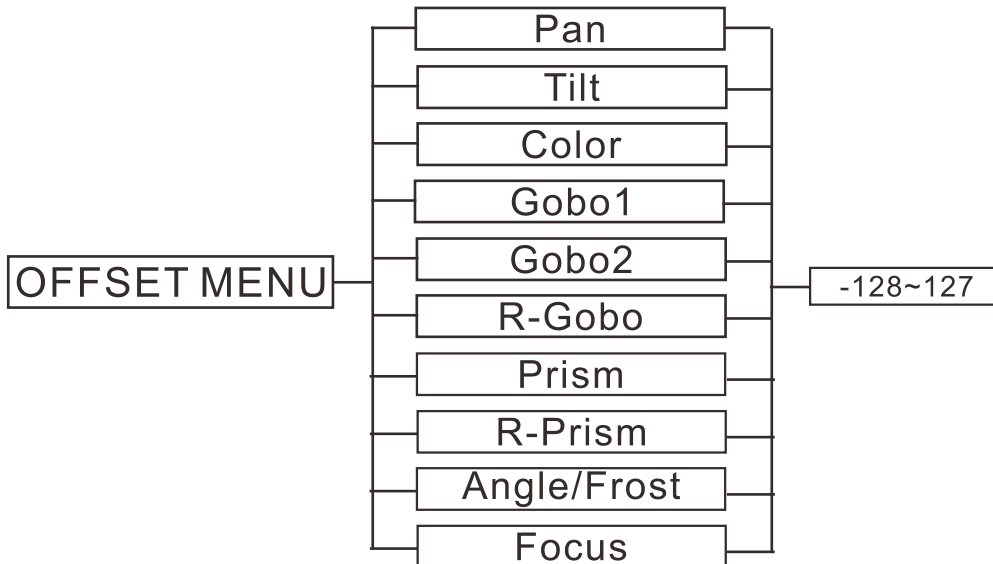

Pan

Enter offset mode, Select **Pan**, press the **ENTER** button to confirm, the present position will blink on the display, use the **UP/DOWN** button to offset the value from -128 to 127, press the **ENTER** button to store. Press the **MENU** button to exit.

Tilt

Enter offset mode, Select **Tilt**, press the **ENTER** button to confirm, the present position will blink on the display, use the **UP/DOWN** button to offset the value from -128 to 127, press the **ENTER** button to store. Press the **MENU** button to exit.

Color

Enter offset mode, Select **Color**, press the **ENTER** button to confirm, the present position will blink on the display, use the **UP/DOWN** button to offset the value from -128 to 127, press the **ENTER** button to store. Press the **MENU** button to exit.

Gobo 1

Enter offset mode, Select **Gobo 1**, press the **ENTER** button to confirm, the present position will blink on the display, use the **UP/DOWN** button to offset the value from -128 to 127, press the **ENTER** button to store. Press the **MENU** button to exit.

Gobo 2

Enter offset mode, Select **Gobo 2**, press the **ENTER** button to confirm, the present position will blink on the display, use the **UP/DOWN** button to offset the value from -128 to 127, press the **ENTER** button to store. Press the **MENU** button to exit.

R-Gobo

Enter offset mode, Select **R-Gobo**, press the **ENTER** button to confirm, the present position will blink on the display, use the **UP/DOWN** button to offset the value from -128 to 127, press the **ENTER** button to store. Press the **MENU** button to exit.

Prism

Enter offset mode, Select **Prism**, press the **ENTER** button to confirm, the present position will blink on the display, use the **UP/DOWN** button to offset the value from -128 to 127, press the **ENTER** button to store. Press the **MENU** button to exit.

R-Prism

Enter offset mode, Select **R-Prism**, press the **ENTER** button to confirm, the present position will blink on the display, use the **UP/DOWN** button to offset the value from -128 to 127, press the **ENTER** button to store. Press the **MENU** button to exit.

Angle/Frost

Enter offset mode, Select **Angle/Frost**, press the **ENTER** button to confirm, the present position will blink on the display, use the **UP/DOWN** button to offset the value from -128 to 127, press the **ENTER** button to store. Press the **MENU** button to exit.

Focus

Enter offset mode, Select **Focus**, press the **ENTER** button to confirm, the present position will blink on the display, use the **UP/DOWN** button to offset the value from -128 to 127, press the **ENTER** button to store. Press the **MENU** button to exit.

6. Control By Universal DMX Controller

6.1 DMX512 Connection

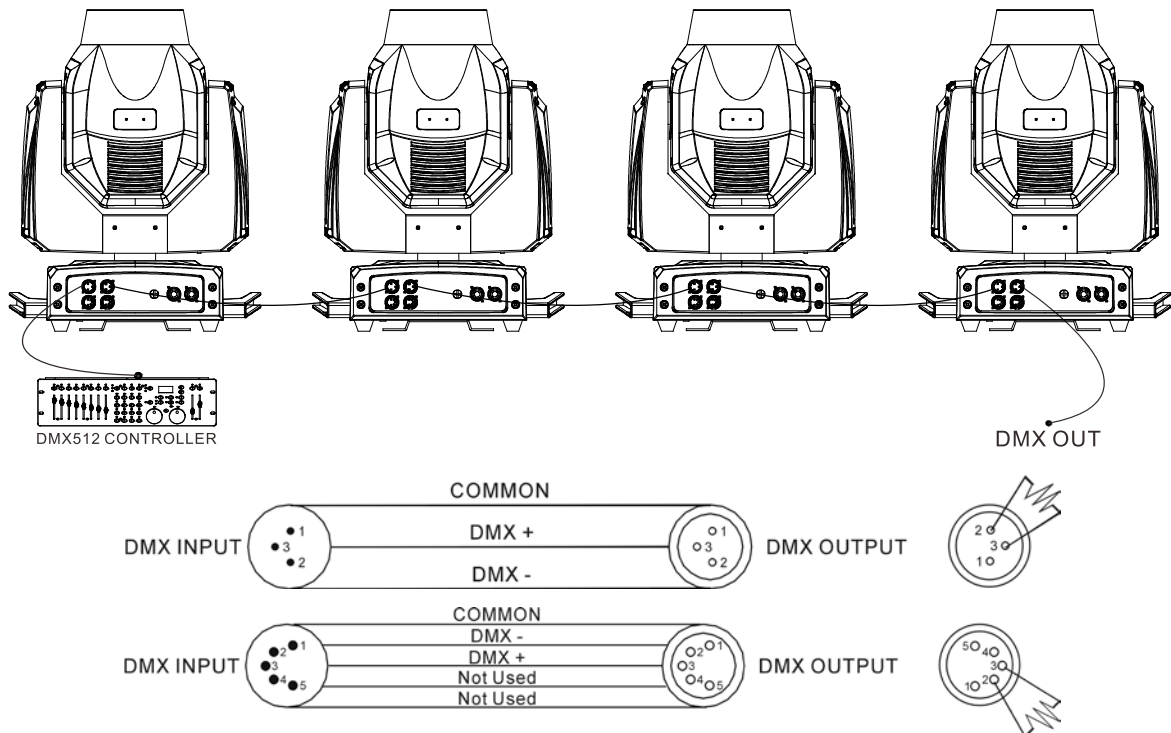

1. At last unit, the DMX cable has to be terminated with a terminator. Solder a 120-ohm 1/4W resistor between pin 2(DMX-) and pin 3(DMX+) into a 3-pin XLR-plug and plug it in the DMX-output of the last unit.
2. Connect the unit together in a “daisy chain” by XLR plug cable from the output of the unit to the input of the next unit. The cable cannot be branched or split to a “Y” cable. DMX 512 is a very high-speed signal. Inadequate or damaged cables, soldered joints or corroded connectors can easily distort the signal and shut down the system.
3. The DMX output and input connectors are pass-through to maintain the DMX circuit, when one of the units’ power is disconnected.
4. Each lighting unit needs to have a DMX address to receive the data by the controller. The address number is between 1-512.
5. The end of the DMX 512 system should be terminated to reduce signal errors.
6. 3 pin XLR connectors are more popular than 5 pins XLR.
 - 3 pin XLR: Pin 1: GND, Pin 2: Negative signal (-), Pin 3: Positive signal (+)
 - 5 pin XLR: Pin 1: GND, Pin 2: Negative signal (-), Pin 3: Positive signal (+), Pin4, Pin5 not used.

6.2 Address Setting

If you use a universal DMX controller to control the units, you have to set DMX address from 1 to 512 so that the units can receive DMX signal.

Press the MENU button to enter menu mode, select DMX Functions, press the ENTER button to confirm, use the UP/DOWN button to select DMX Address, press the ENTER button to confirm, the present address will blink in the display, use the UP/DOWN button to adjust the address from 001 to 512, press the ENTER button to store. Press the MENU button back to the last menu or let the unit idle 30 seconds to exit menu mode.

Please refer to the following diagram to address your DMX512 channel for the first 4 units.

Channel mode	Unit 1 Address	Unit 2 Address	Unit 3 Address	Unit 4 Address
16 channels	1	17	33	49
19 channels	1	20	39	58

6.3 DMX512 Configuration

Please control the fixture by referring to the configurations below

Attentions:

1. The unit will maintain the last condition until reset if you cut-off the DMX signal.
2. For the channel Function, keep the value for about 3 seconds, then the corresponding function will take into effect.

16 Channels (Mode 1):

CHANNEL	VALUE	FUNCTION
1	000-255	PAN 0°→540°
2	000-255	TILT 0°→240°
3	000-255	PAN/TILT SPEED Fast to Slow
4	000-007 008-063 064-127 128-191	SHOW MODE Null Show 1 Show 2 Show 3

	192-255	Show 4
5	000-007 008-015 016-023 024-031 032-039 040-047 048-055 056-064 065-127 128-189 190-193 194-255	COLOR Open Color 1 Color 2 Color 3 Color 4 Color 5 Color 6 Color 7 Color Index Clockwise Rotation, Fast to Slow Stop Counter-clockwise Rotation, Slow to Fast
6	000-006 007-013 014-020 021-027 028-034 035-041 042-048 049-055 056-062 063-069 070-083 084-087 088-092 093-097 098-102 103-107 108-112 113-117 118-122 123-127 128-189 190-193 194-255	GOBO 1 Open Gobo1 Gobo2 Gobo3 Gobo4 Gobo5 Gobo6 Gobo7 Gobo8 Gobo9 Open Gobo1 Shaking Gobo2 Shaking Gobo3 Shaking Gobo4 Shaking Gobo5 Shaking Gobo6 Shaking Gobo7 Shaking Gobo8 Shaking Gobo9 Shaking Counter-clockwise Rotation, Fast to Slow Stop Clockwise Rotation, Slow to Fast
7	000-010 011-021 022-032 033-043 044-054 055-065 066-076	GOBO 2 Open Gobo1 Gobo2 Gobo3 Gobo4 Gobo5 Gobo6

	077-087 088-092 093-097 098-102 103-107 108-112 113-117 118-122 123-127 128-189 190-193 194-255	Gobo7 Open Gobo1 Shaking Gobo2 Shaking Gobo3 Shaking Gobo4 Shaking Gobo5 Shaking Gobo6 Shaking Gobo7 Shaking Counter-clockwise Rotation, Fast to Slow Stop Clockwise Rotation, Slow to Fast
8	000-127 128-189 190-193 194-255	R-GOBO 2 Gobo Index Clockwise Rotation, Fast to Slow Stop Counter-clockwise Rotation, Slow to Fast
9	000-007 008-255	PRISM(6-facet prism) No Effect Prism Effect
10	000-127 128-189 190-193 194-255	R-PRISM Index Counter-clockwise Rotation, Fast to Slow Stop Clockwise Rotation, Slow to Fast
11	000-007 008-128 129-255	ANGLE/FROST Open Angle Frost
12	000-255	FOCUS 0%→100%
13	000-007 008-015 016-131 132-139 140-181 182-189 190-231 232-239 240-247 248-255	SHUTTER Close Open Strobe from Slow to Fast Open Slow Open Fast Close Open Slow Close Fast Open Open Random Strobe Open
14	000-255	DIMMER 0%→100%
15	000-009	FUNCTION Null

	010-019 020-029 030-069 070-079 080-089 090-099 100-109 110-119 120-129 130-139 140-149 150-159 160-199 200-209 230-255	Enable Auto Focus Disable Auto Focus Null Enable Blackout While Pan/Tilt Moving Disable Blackout While Pan/Tilt Moving Enable Blackout While Color Changing Disable Blackout While Color Changing Enable Blackout While Gobo Changing Disable Blackout While Gobo Changing Null Pan/Tilt Reset Effect Reset Null All Reset Null
16	000-063 064-127 128-191 192-255	AUTO FOCUS 5m 10m 15m Default to Unit

19 Channels (Mode 2):

CHANNEL	VALUE	FUNCTION
1	000-255	PAN 0°→540°
2	000-255	PAN FINE
3	000-255	TILT 0°→240°
4	000-255	TILT FINE
5	000-255	PAN/TILT SPEED Fast to Slow
6	000-007 008-063 064-127 128-191 192-255	SHOW MODE Null Show 1 Show 2 Show 3 Show 4
7	000-007 008-015 016-023 024-031	COLOR Open Color 1 Color 2 Color 3

	032-039 040-047 048-055 056-064 065-127 128-189 190-193 194-255	Color 4 Color 5 Color 6 Color 7 Color Index Clockwise Rotation, Fast to Slow Stop Counter-clockwise Rotation, Slow to Fast
8	000-006 007-013 014-020 021-027 028-034 035-041 042-048 049-055 056-062 063-069 070-083 084-087 088-092 093-097 098-102 103-107 108-112 113-117 118-122 123-127 128-189 190-193 194-255	GOBO 1 Open Gobo1 Gobo2 Gobo3 Gobo4 Gobo5 Gobo6 Gobo7 Gobo8 Gobo9 Open Gobo1 Shaking Gobo2 Shaking Gobo3 Shaking Gobo4 Shaking Gobo5 Shaking Gobo6 Shaking Gobo7 Shaking Gobo8 Shaking Gobo9 Shaking Counter-clockwise Rotation, Fast to Slow Stop Clockwise Rotation, Slow to Fast
9	000-010 011-021 022-032 033-043 044-054 055-065 066-076 077-087 088-092 093-097 098-102 103-107 108-112 113-117	GOBO 2 Open Gobo1 Gobo2 Gobo3 Gobo4 Gobo5 Gobo6 Gobo7 Open Gobo1 Shaking Gobo2 Shaking Gobo3 Shaking Gobo4 Shaking Gobo5 Shaking

	118-122 123-127 128-189 190-193 194-255	Gobo6 Shaking Gobo7 Shaking Counter-clockwise Rotation, Fast to Slow Stop Clockwise Rotation, Slow to Fast
10	000-127 128-189 190-193 194-255	R-GOBO 2 Gobo Index Clockwise Rotation, Fast to Slow Stop Counter-clockwise Rotation, Slow to Fast
11	000-007 008-255	PRISM(6-facet prism) No Effect Prism Effect
12	000-127 128-189 190-193 194-255	R-PRISM Index Counter-clockwise Rotation, Fast to Slow Stop Clockwise Rotation, Slow to Fast
13	000-007 008-128 129-255	ANGLE/FROST Open Angle Frost
14	000-255	FOCUS 0%→100%
15	000-007 008-015 016-131 132-139 140-181 182-189 190-231 232-239 240-247 248-255	SHUTTER Close Open Strobe from Slow to Fast Open Slow Open Fast Close Open Slow Close Fast Open Open Random Strobe Open
16	000-255	DIMMER 0%→100%
17	000-255	DIMMER FINE
18	000-009 010-019 020-029 030-069 070-079 080-089	FUNCTION Null Enable Auto Focus Disable Auto Focus Null Enable Blackout While Pan/Tilt Moving Disable Blackout While Pan/Tilt Moving

	090-099 100-109 110-119 120-129 130-139 140-149 150-159 160-199 200-209 230-255	Enable Blackout While Color Changing Disable Blackout While Color Changing Enable Blackout While Gobo Changing Disable Blackout While Gobo Changing Null Pan/Tilt Reset Effect Reset Null All Reset Null
19	000-063 064-127 128-191 192-255	AUTO FOCUS 5m 10m 15m Default to Unit

7. Troubleshooting

Following are a few common problems that may occur during operation. Here are some suggestions for troubleshooting:

A. The unit does not work, no light and the fan does not work

1. Check the connected power.
2. Measure the voltage.
3. Check the power indicator to see whether it can be lit up or not.

B. Not responding to the DMX controller

1. Check whether the DMX connectors and the DMX cables are connected correctly.
2. Check whether the DMX address is correctly set.
3. If the intermittent DMX signal problem occurs, check whether the XLR socket and the signal cable are well connected.
4. Try it with another DMX controller.
5. Check whether the DMX cables run near or alongside to the high-voltage cables, which may damage or interfere with the signal circuit.

C. One of the channels is not working well

1. The stepper motor might be damaged or the cable connected to the PCB might be broken.
2. The motor's drive IC on the PCB might be out of condition.

8. Fixture Cleaning

It is absolutely essential that the fixture is kept clean to ensure the maximum light-output and allow the fixture to function reliably throughout its life. The fixture must be cleaned regularly to avoid dust, dirt and smoke-fluid residues building up on or within the fixture. The cleaning frequency depends on the application environment. Clean the fixture immediately if the dust enters it to avoid damage to the optical lens due to excessive dust.

- A soft lint-free cloth moistened with any good glass cleaning fluid is recommended, under no circumstances should solvents be used.
- Always dry the parts carefully.
- Clean the external optical lens at least every 20 days and the internal optical lens every 30 days.

Innovation, Quality, Performance