

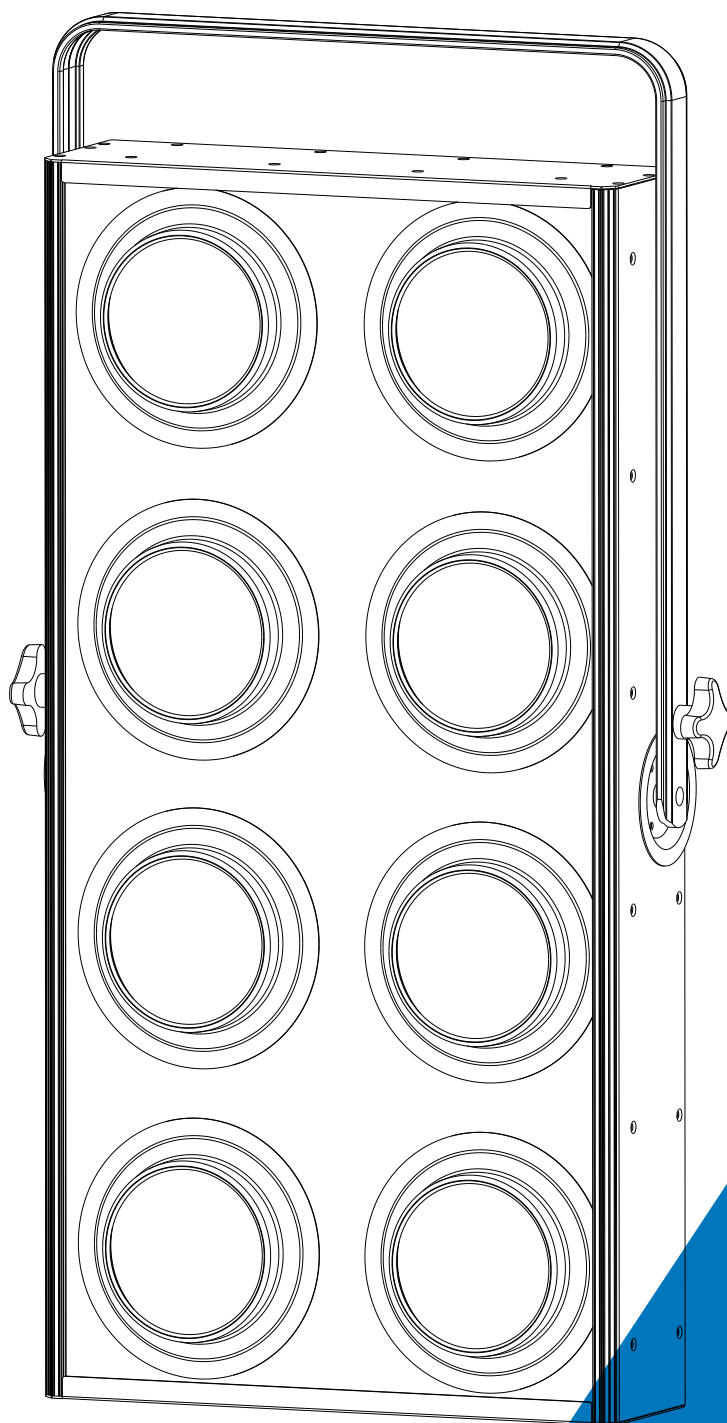

Stage Blender P8



User Manual

Please read the instruction carefully before use

Contents

| | |
|-----------------------------------|----|
| 1. Safety Instructions | 2 |
| 2. Technical Specifications | 4 |
| 3. Installation | 5 |
| 4. How to set the unit..... | 5 |
| 4.1 Rear Panel..... | 5 |
| 4.2 Main Function | 7 |
| 5. How To Control The Unit..... | 9 |
| 6. DMX Channel Mode..... | 11 |
| 7. DMX512 Connections..... | 12 |
| 8. Troubleshooting | 12 |
| 9. Fixture Cleaning..... | 13 |

1. Safety Instructions



WARNING

Please read the instructions carefully which includes important information about the installation, operation and maintenance.



WARNING!

- Please keep this User Manual for future consultation. If you sell the fixture to another user, be sure that they also receive this instruction booklet.
- Please unpack and check carefully there is no transportation damage before using the fixture.
- Please disconnect main power before servicing and maintenance.
- The unit must be installed in a location with adequate ventilation, at least 50cm from adjacent surfaces. Be sure that no ventilation slots are blocked.
- The maximum ambient temperature is $T_a: 40^{\circ}\text{C}$. DO NOT operate it where the temperature is higher than this.
- DO NOT connect the device to any dimmer pack.
- The housing must be replaced if they are visibly damaged.
- Unit surface temperature may reach up to 85°C . Don't touch the housing bare-hand during its operation. Turn off the power and allow about 15 minutes for the unit to cool down before replacing or serving.
- There are no user serviceable parts inside the fixture. Do not open the housing or attempt any repairs by yourself. In the unlikely event your fixture may require

service, please contact your nearest dealer.

- In the event of serious operating problem, stop using the fixture immediately. Never try to repair the fixture by yourself. Repairs carried out by unskilled people can lead to damage or malfunction. Please contact the nearest authorized technical assistance center. Always use the same type spare parts.



- **DANGER!** It's important to ground the yellow/green conductor to earth in order to avoid electric shock.
- **DO NOT** touch any wire during operation and there might be a hazard of electric shock.



- **WARNING!** **DO NOT** expose the fixture to rain or moisture, in order too prevent or reduce the risk of electrical shock or fire.



- **Warning!** Do not look directly at the LED light beam while the fixture is on.

For AC 220—240V 50Hz power supply, the maximum fixtures that can be connected on one power cable is 4 (including the first fixture) ;

For AC 100–120V 60Hz power supply, the maximum fixtures that can be connected on one power cable are 2 (including the first fixture).

2. Technical Specifications

- DMX 1/2/8/9 channels switchable.
- Smooth 0~100% dimming and variable strobe speeds.
- Two operation modes: DMX, Manual mode.
- Ideal for discotheques, clubs, bars, parties, Mobile DJs, etc.
- **Input Voltage:** AC 100V~240V 50/60Hz
- **Total Power consumption:** 800W
- **Fuse:** T10A
- **LED:** 8 x 65W LED
- **Dimension:** 893 x 508 x 182mm
- **Weight:** 17.5Kgs

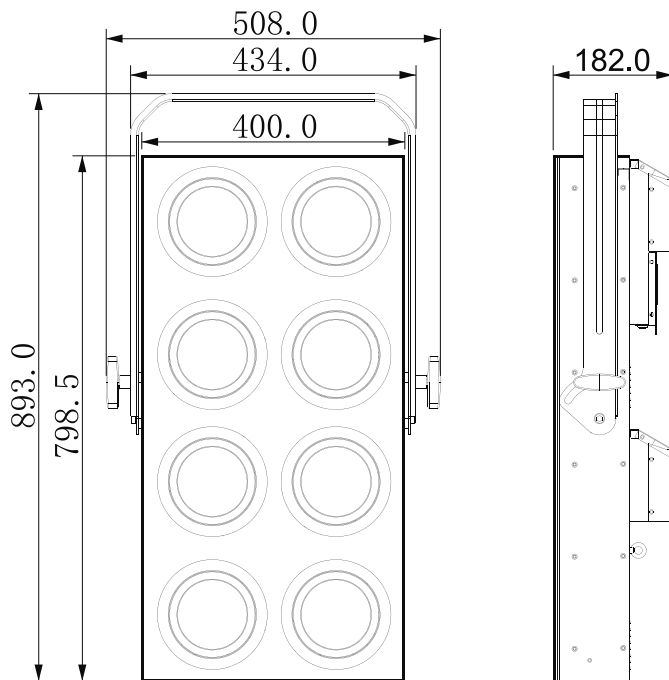

3. Installation

The unit should be mounted via its screw holes on the bracket. Always ensure that the unit is firmly fixed to avoid vibration and slipping while operating. Always ensure that the structure to which you are attaching the unit is secure and is able to support a weight of 10 times of the unit's weight. Also always use a safety cable that can hold 12 times of the weight of the unit when installing the fixture.

The equipment must be fixed by professionals. And it must be fixed at a place where is out of the touch of people and has no one pass by or under it.

4. How to set the unit

4.1 Rear Panel

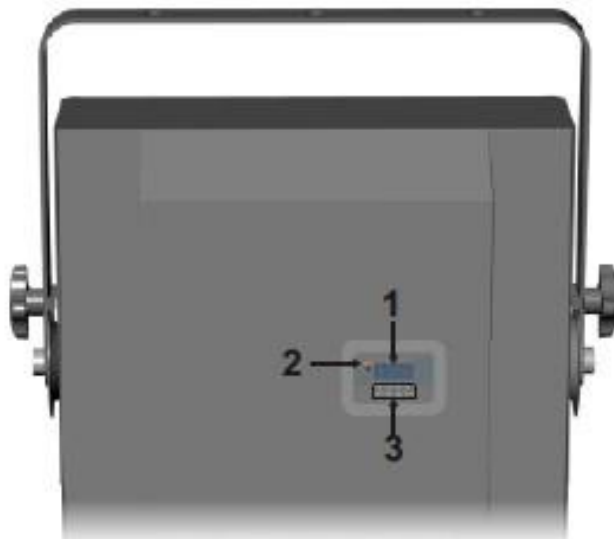

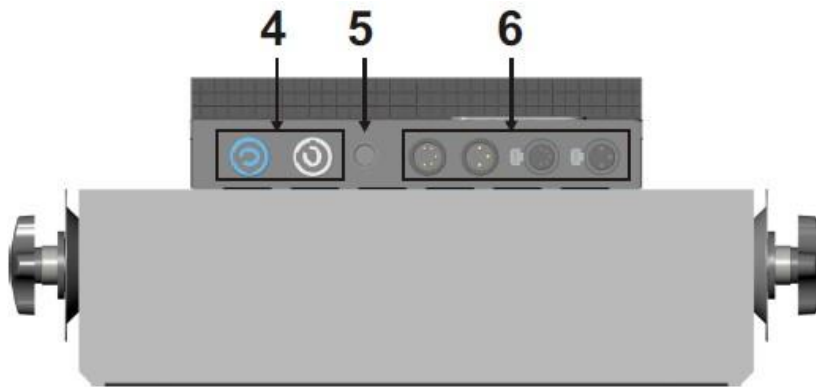

① **Display:** Show the various menus and the selected functions

② **LED:**

| | | |
|-----|----|-------------------|
| DMX | On | DMX input present |
|-----|----|-------------------|

③ **Button:**

| | |
|-------|--|
| MENU | To select the programming functions |
| DOWN | To go backward in the selected functions |
| UP | To go forward in the selected functions |
| ENTER | To confirm the selected functions |

④ **Mains input/output:**

Connect to supply mains power, and Connect to supply mains power for the next unit.

⑤ **Fuse:** 10 A

⑥ **DMX input/output:**

For DMX512 link, use 3/5-pin XLR plug cable to input DMX signal, and to link the next unit.

4.2 Main Function

To select any functions, press **MENU** button until the required one is shown on the display. Select the function by **ENTER** button. Use **DOWN** and **UP** button to change the mode. Once the required mode has been selected, press **ENTER** button to setup or it will automatically return to the main functions without any change after idling 30 seconds. Back to the functions without any change press **MENU** button. The main functions are shown below:

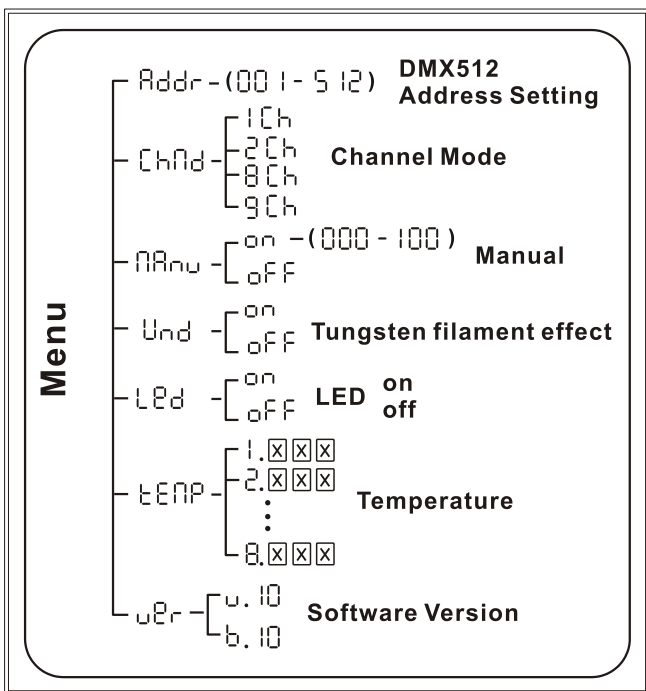

Addr DMX 512 Address

Select the **Addr**, press the **ENTER** button and the display will blink. Use the **DOWN** and **UP** button to change the DMX 512 address. Once the address has been selected, press the **ENTER** button to setup or exit menu mode without any change after 30

seconds automatically. Back to the previous functions without any change press the **MENU** button.

Chan Channel Mode

Select the **Chan**, press the **ENTER** button. Use the **DOWN** and **UP** button to select the channel mode (1 /2/8/9). Once selected, press the **ENTER** button to setup or exit menu mode without any change after 30 seconds automatically. To go back to the functions without any change press the **MENU** button

Manu Manual Mode

Select the **Manu**, press the **ENTER** button. Use the **DOWN** and **UP** button to select **ON**/**OFF**, after selected, press the **ENTER** button. If you select the **ON**, press the **ENTER** button, use the **DOWN** and **UP** button to select 000–100, and press the **ENTER** button to setup or exit menu mode without any change after 30 seconds automatically. To go back to the functions without any change press the **MENU** button

Und Tungsten Filament Effect

Select the **Und**, press the **ENTER** button. Use the **DOWN** and **UP** button to select **on** (the effect will display when the light turn off or move) or **off**(the effect won't display when the light turn off or move). Once selected, press the **ENTER** button to setup or exit menu mode without any change after 30 seconds

automatically. Back to the functions without any change press the **MENU** button again.

LED LED display

Select the **LED**, press the **ENTER** button. Use the **DOWN** and **UP** button to select **on** (LED display on) or **off**(LED display off). If you choose OFF, than the LED display will close without any operation for 1 min. Once selected, press the **ENTER** button to setup or exit menu mode without any change after 30 seconds automatically. Back to the functions without any change press the **MENU** button again.

TEMP Temperature Display

Select the **TEMP**, press **ENTER** button and the display will show the temperature of each unit **1-x x**..... To go back to the functions press the **MENU** button.

VER Firmware version

Select the **VER**, press **ENTER** button and the display will show the version of software of the unit. To go back to the functions press the **MENU** button.

5. How To Control The Unit

You can operate the unit in two ways:



1. By manual controller









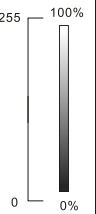
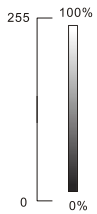





2. By DMX controller

No need to turn the unit off when you change the DMX address, as new DMX address setting will be affected at once. Turn on the unit, if there is DMX or without DMX and manual mode turn off, the LED will display the saved channel address (001-512) ; If there isn't DMX and manual mode turn on, the LED will display saved manual address. (D000-D100).

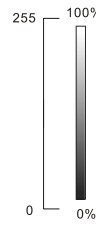
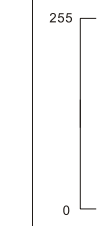
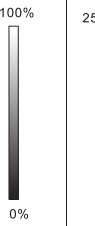
6. DMX512 Channel Mode

Channel mode:

| 1-CH Mode | | 2-CH Mode | |
|--|--|---|--|
|  Dimmer | CH 1  Dimmer | CH 2  Flash rate | |
|  <p>255 100% 0 0%</p> |  <p>255 100% 0 0%</p> | <p>250-255 Open 191-249 4 LEDs random strobe respectively 186-190 Open 128-185 4 LEDs random strobe at the same time 124-127 Open 6-123 Strobe slow to fast 0-5 Open</p> | |

| 8-CH Mode | | | | | | | |
|--|--|--|--|--|--|--|--|
| CH 1  Dimmer | CH 2  Dimmer | CH 3  Dimmer | CH 4  Dimmer | CH 5  Dimmer | CH 6  Dimmer | CH 7  Dimmer | CH 8  Dimmer |
|  <p>255 100% 0 0%</p> |  <p>255 100% 0 0%</p> |  <p>255 100% 0 0%</p> |  <p>255 100% 0 0%</p> |  <p>255 100% 0 0%</p> |  <p>255 100% 0 0%</p> |  <p>255 100% 0 0%</p> |  <p>255 100% 0 0%</p> |

| 9-CH Mode | | | | | | | | |
|------------------|------------------|------------------|------------------|------------------|------------------|------------------|------------------|---|
| CH 1 | CH 2 | CH 3 | CH 4 | CH 5 | CH 6 | CH 7 | CH 8 | CH 9 |
| Dimmer | Dimmer | Dimmer | Dimmer | Dimmer | Dimmer | Dimmer | Dimmer | Flash rate |
| 255 100% 0 | 255 100% 0 | 255 100% 0 | 255 100% 0 | 255 100% 0 | 255 100% 0 | 255 100% 0 | 255 100% 0 | 250~255 Open 191~249 4 LEDs random strobe respectively 186~190 Open 128~185 4 LEDs random strobe at the same time 124~127 Open 6~123 Strobe slow to fast 0~5 Open |

7. DMX512 Connections

Mode connection:

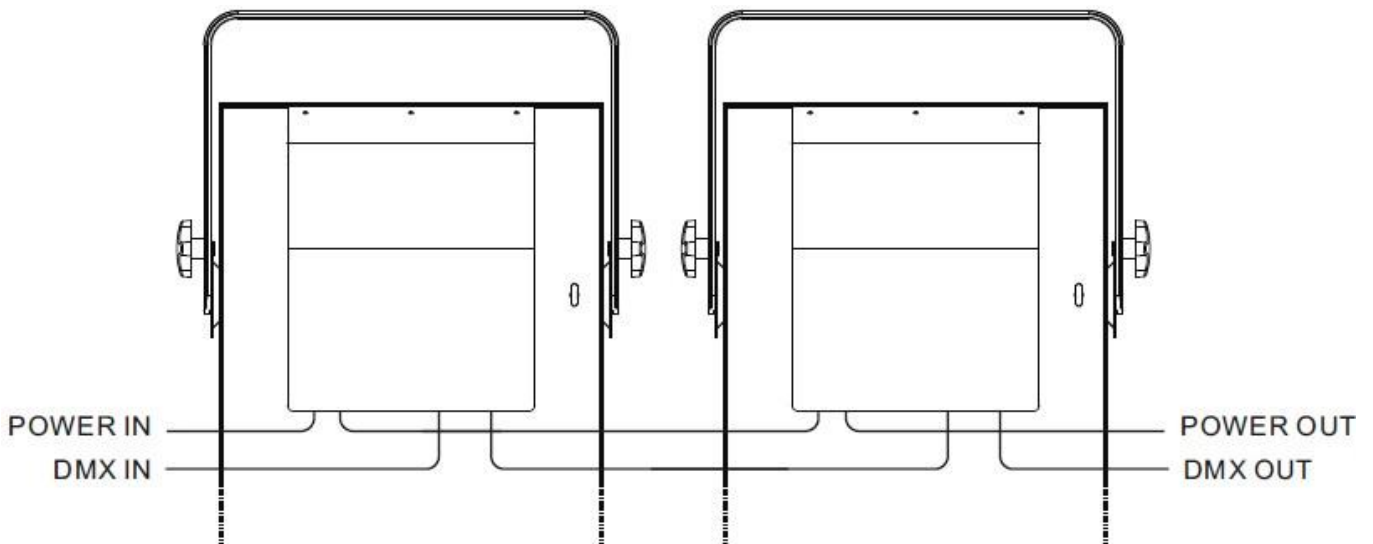

1. Connect the fixture together in a “daisy chain” by XLR plug cable from the output of the fixture to the input of the next fixture. The cable cannot be branched or split to a “Y” cable. Inadequate or damaged cables, soldered joints or corroded connectors can easily distort the signal and shut down the system
2. The DMX output and input connectors are pass-through to maintain the DMX circuit when one of the units’ power is disconnected.

3. At last fixture, the DMX cable has to be terminated with a terminator to reduce signal errors. Solder a 120-ohm 1/4W resistor between pin 2(DMX-) and pin 3(DMX+) into a 3-pin XLR-plug and plug it in the DMX-output of the last fixture.
4. Each lighting fixture needs to have an address set to receive the data sent by the controller. The address number is between 0-511 (usually 0 & 1 are equal to 1).
5. 3 pin XLR connectors are more popular than 5 pins XLR.
3 pin XLR: Pin 1: GND, Pin 2: Negative signal (-), Pin 3: Positive signal (+)
5 pin XLR: Pin 1: GND, Pin 2: Negative signal (-), Pin 3: Positive signal (+),
Pin4/5: not used

8. Troubleshooting

Following are a few common problems that may occur during operation. Here are some suggestions for easy troubleshooting:

A. The fixture does not work, no light

1. Check the connection of power and main fuse.
2. Measure the mains voltage on the main connector.

B. Not responding to DMX controller

1. DMX LED should be on. If not, check DMX connectors, cables to see if link properly.
2. If the DMX LED is on and no response to the channel, check the address settings

and DMX polarity.

3. If you have intermittent DMX signal problems, check the pins on connectors or on PCB of the fixture or the previous one.
4. Try to use another DMX controller.
5. Check if the DMX cables run near or run alongside to high voltage cables that may cause damage or interference to DMX interface circuit.

C. One of the channels is not working well

1. The stepper motor might be damaged or the cable connected to the PCB is broken.
2. The motor's drive IC on the PCB might be out of condition.

9. Fixture Cleaning

The cleaning of internal must be carried out periodically to optimize light output.

Cleaning frequency depends on the environment in which the fixture operates:

damp, smoky or particularly dirty surrounding can cause greater accumulation of dirt on the fixture's optics.

- Clean with soft cloth using normal glass cleaning fluid.
- Always dry the parts carefully.
- Clean the external optics at least every 20 days. Clean the internal optics at least every 30/60 days.

Fresnel lens:

Clean the lens with neutral soap and water, and then dry it with soft cloth. Be aware that alcohol or other detergent could cause damage to lens. Please note the lens would be burnt yellow or cracked after three-month use of average 8 hours per day, which can reduce the output in some degree. The lens is consumable with a warranty of three months only. Please change with genuinely new lens when necessary.

=

Innovation, Quality, Performance